



# STEEL

Architecturally  
Exposed Structural  
Steel

**TENSION**

Part 1



Tension  
i.e.

STRETCHING

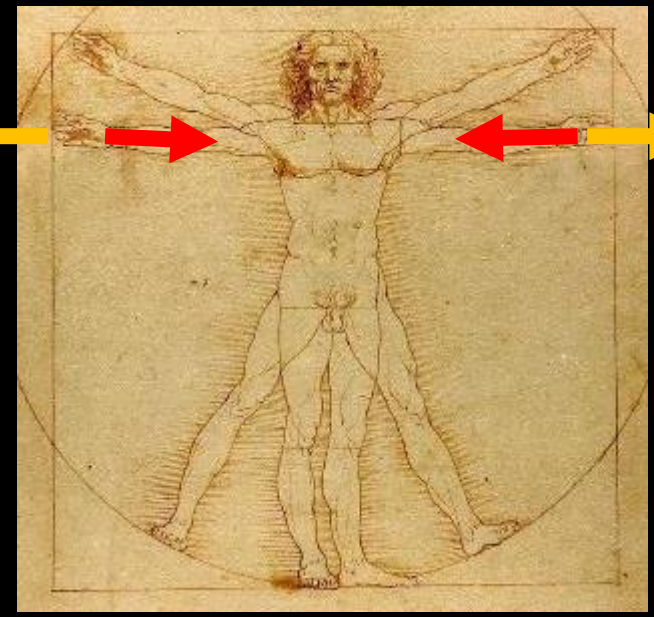









**WROUGHT-IRON RODS** provided a rigid support for the exterior walls of the Crystal Palace, which had an internal wall to stiffen it. Visible from inside and out (the interior view is shown here), these cross braces added to the building's strikingly contemporary appearance.

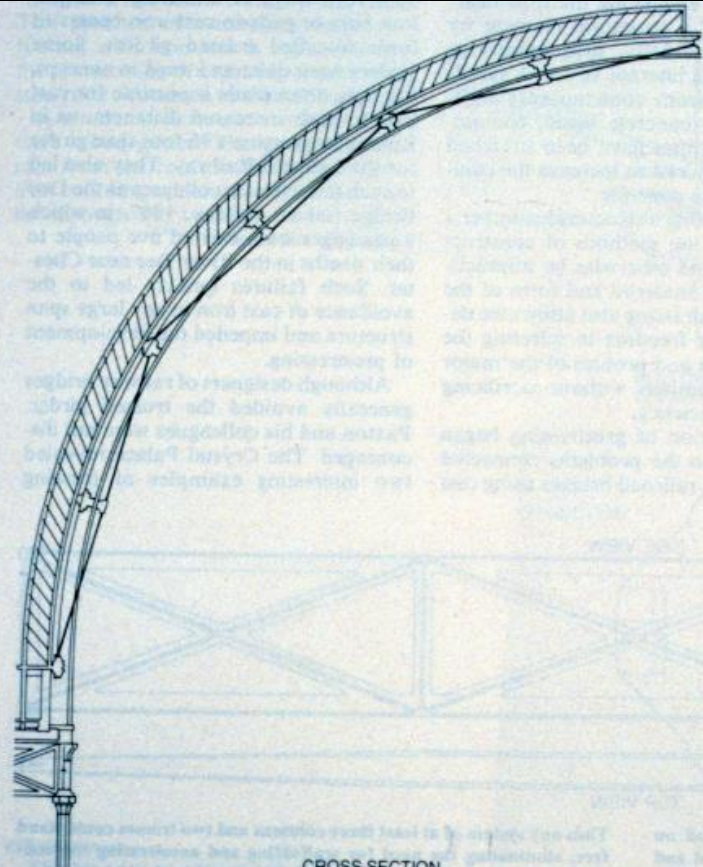
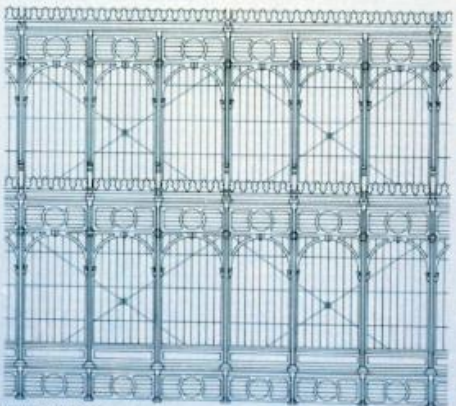

CROSS SECTION

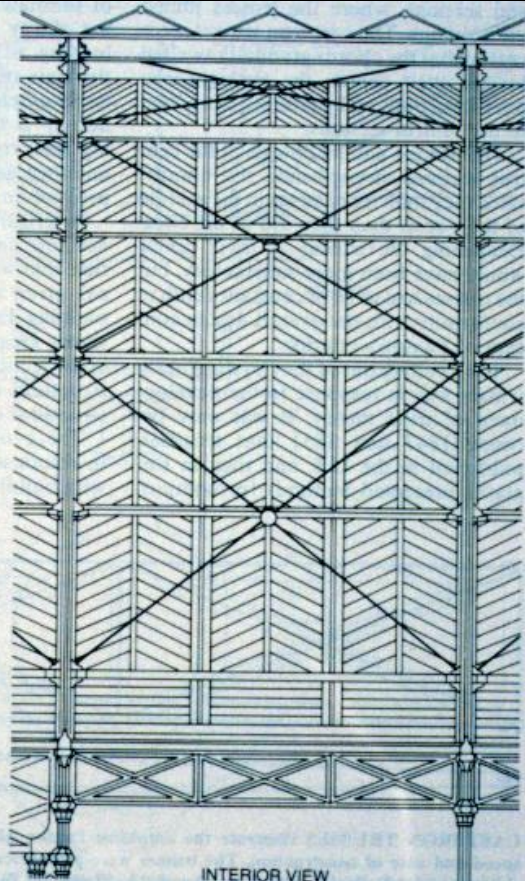

INTERIOR VIEW

cables = steel "rope"

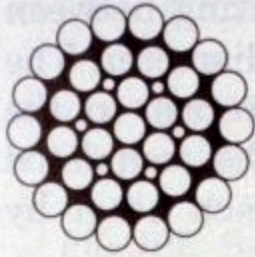

*(a) Galvanized Bridge Strand*

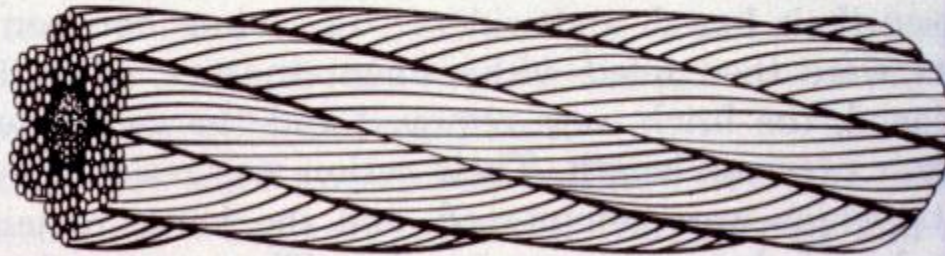
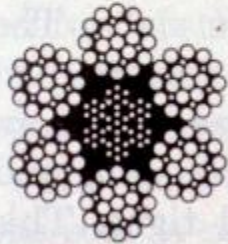

*(b) Galvanized Bridge Rope*

FIGURE 6.43 Wire strand and rope.





Brooklyn Bridge  
New York City, USA  
John A. Roebling  
1893

- For Tension structures there is a choice between using **cables** or **rods**.
- If the intended in situ is one of suspension (curved final form) then it will usually be cables
- For X bracing, we usually use rods as they will be stiffer when being installed.
- For exterior use cables must be given a weather proof casing to prevent corrosion
- End connectors are normally clevis type.
- Must include the ability to tighten the members as they need to be installed loose, connected, then tightened.

Do I use a cable or a rod?

- Cables can be extremely long and so are used where length is an issue
- Rods are limited to shipping lengths and are never spliced, so must fit on the bed of a standard long transport truck



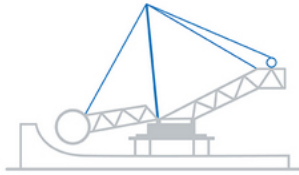

**Bucket Wheel Excavators  
and Spreaders**

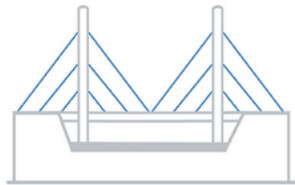

**Cable Stayed Bridges**



**Giant Observation Wheels**

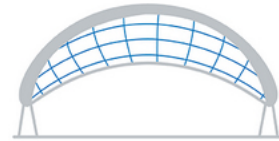

**Glass & Membrane Roofs**



**Glass Facades Systems**

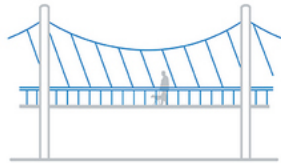

**Pedestrian & Cycling Bridges**

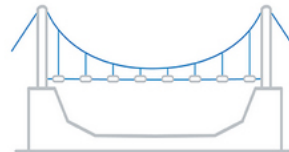

**Pipeline Bridges & Suspension**

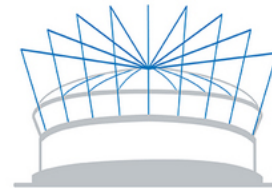

**Stadium & Arena Roofs**



**Stayed Masts & Towers**



**Stayed Windturbine, Transmission  
Towers and Offshore Platforms**



**Suspension Bridges**

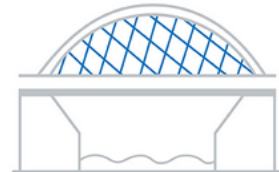

**Tied Arch Bridges**

# Open Socket

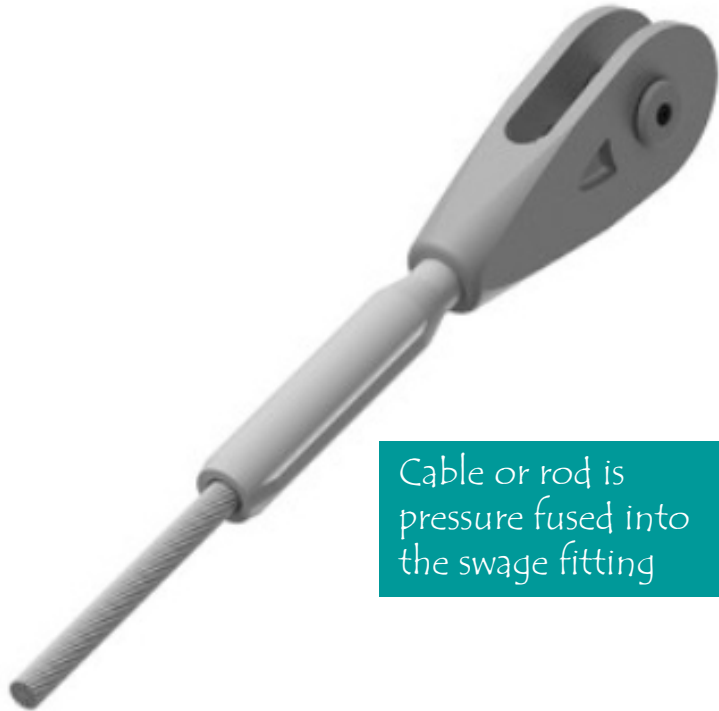

Cable or rod is  
pressure fused into  
the swage fitting

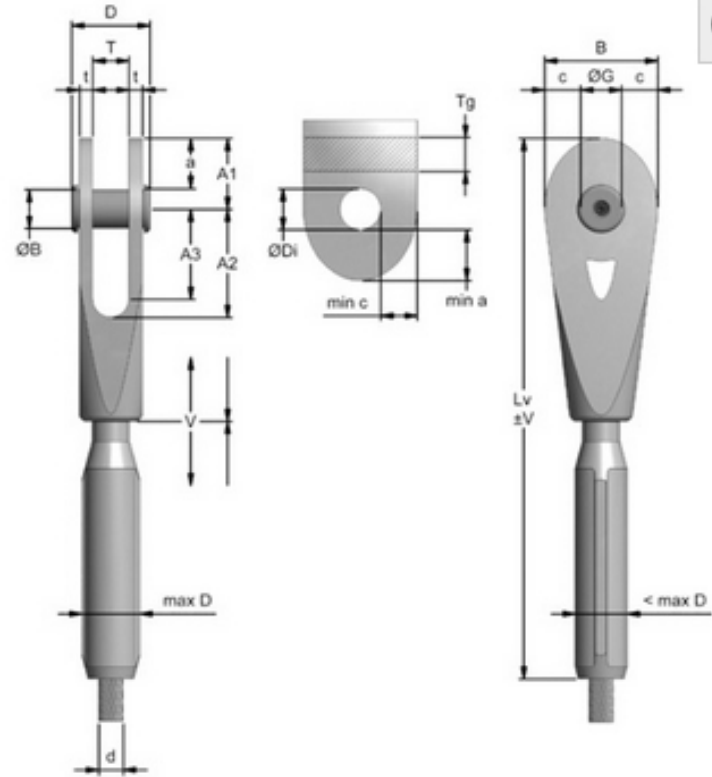

Types we will look at include:

- Simple X bracing applications
- Suspension structures
- Fabric structures
- Mast and Cable support systems
- Force differentiated structures (trusses, tensegrity)
- More innovative use of tension members to create large roof spans
  
- Cable based glazing systems will be looked at in our steel and glazing lecture



# SUSPENSION SYSTEMS



Capilano Cliff Walk  
Vancouver, B.C.  
Morrison Hershfield Engineers  
Solid Rock Steel Fabricators  
2011





























Reichstag Dome  
Berlin, Germany  
Foster and Partners  
2004































Shanghai, China  
Wil Alsop branch firm















Gardens by the Bay  
Singapore  
Wilkinson Eyre Architects  
Grant Associates  
2012



































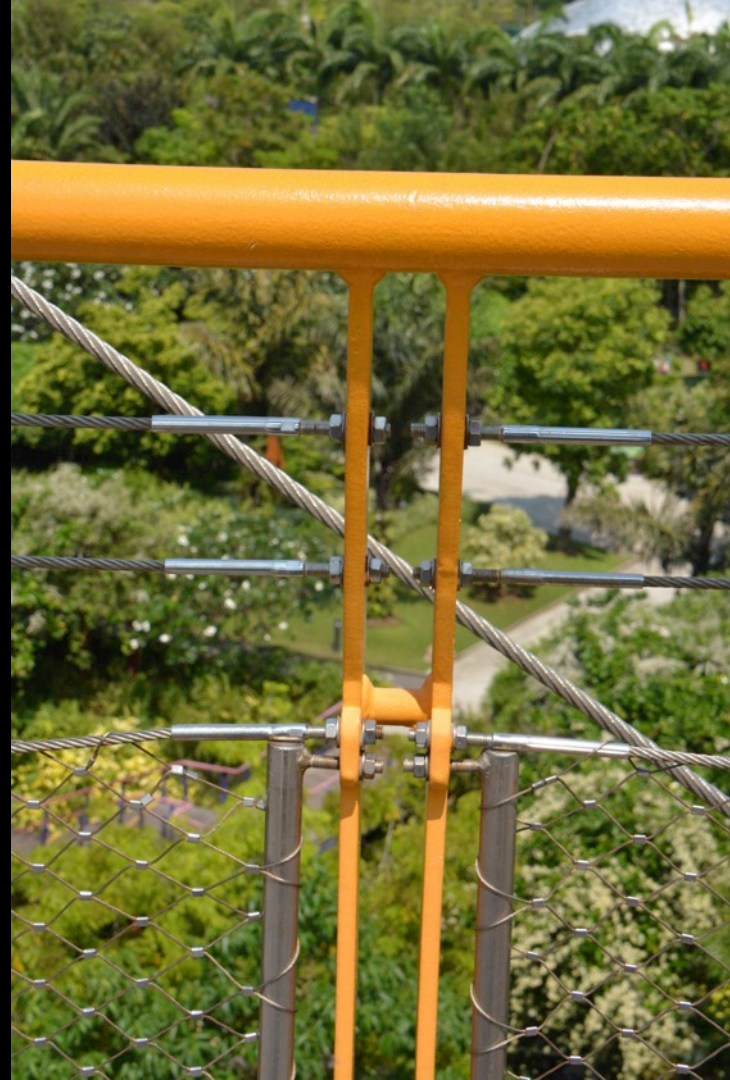



























































Zubizuri Bridge  
Tied Arch, 75m span  
Bilbao, Spain  
Santiago Calarava  
1997







































# X BRACING SYSTEMS



TSK Design Studio  
Henderson, Nevada  
TSK Architects  
1994





709

























Munich Airport  
Munich, Germany  
1994









A photograph of the Northumbria University School of Design building in Newcastle-upon-Tyne, U.K. The building features a prominent cylindrical tower with vertical blue metallic cladding and a curved glass facade with a complex, multi-level structure. The Northumbria University logo is visible on the upper part of the building. The sky is clear blue, and there are some trees and a street lamp in the foreground.

Northumbria University  
School of Design  
Newcastle-upon-Tyne, U.K.  
Atkins  
2008

























APEGBC Headquarters  
Vancouver, B.C.  
Peter Busby and Associates  
2002

















Kant-Dreieck Office Building  
Berlin, Germany  
Josef Paul Kleihues













Burj Al Arab  
Dubai, UAE  
WS Atkins Architects  
1999











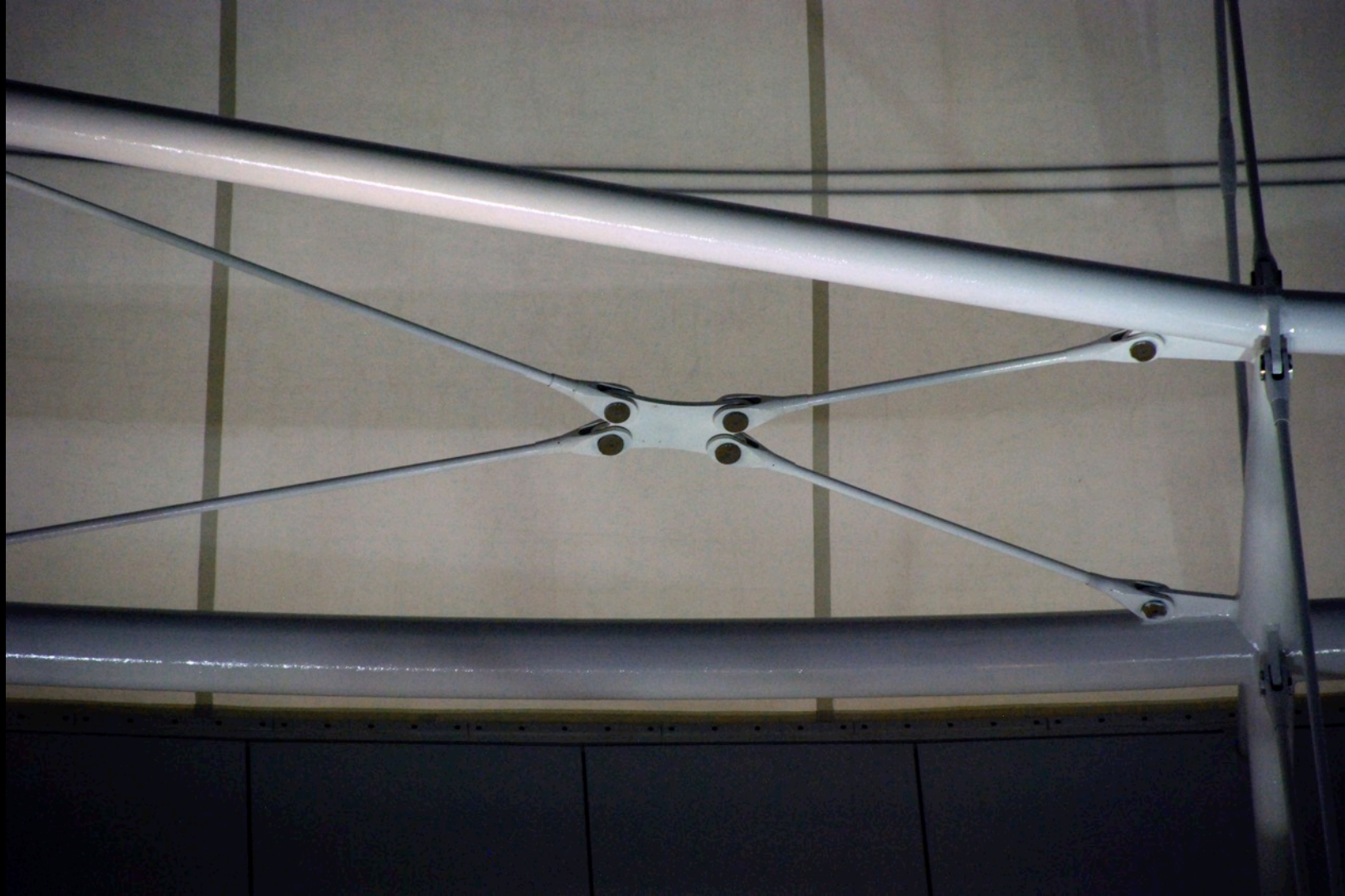



















FORCE DIFFERENTIATED STRUCTURES





Grand Arch La Defense  
Paris, France  
Paul Andreu  
1985









VISITE  
TEL: 02 70 00 00 00  
WWW.PARIS-BOULEVARD.COM



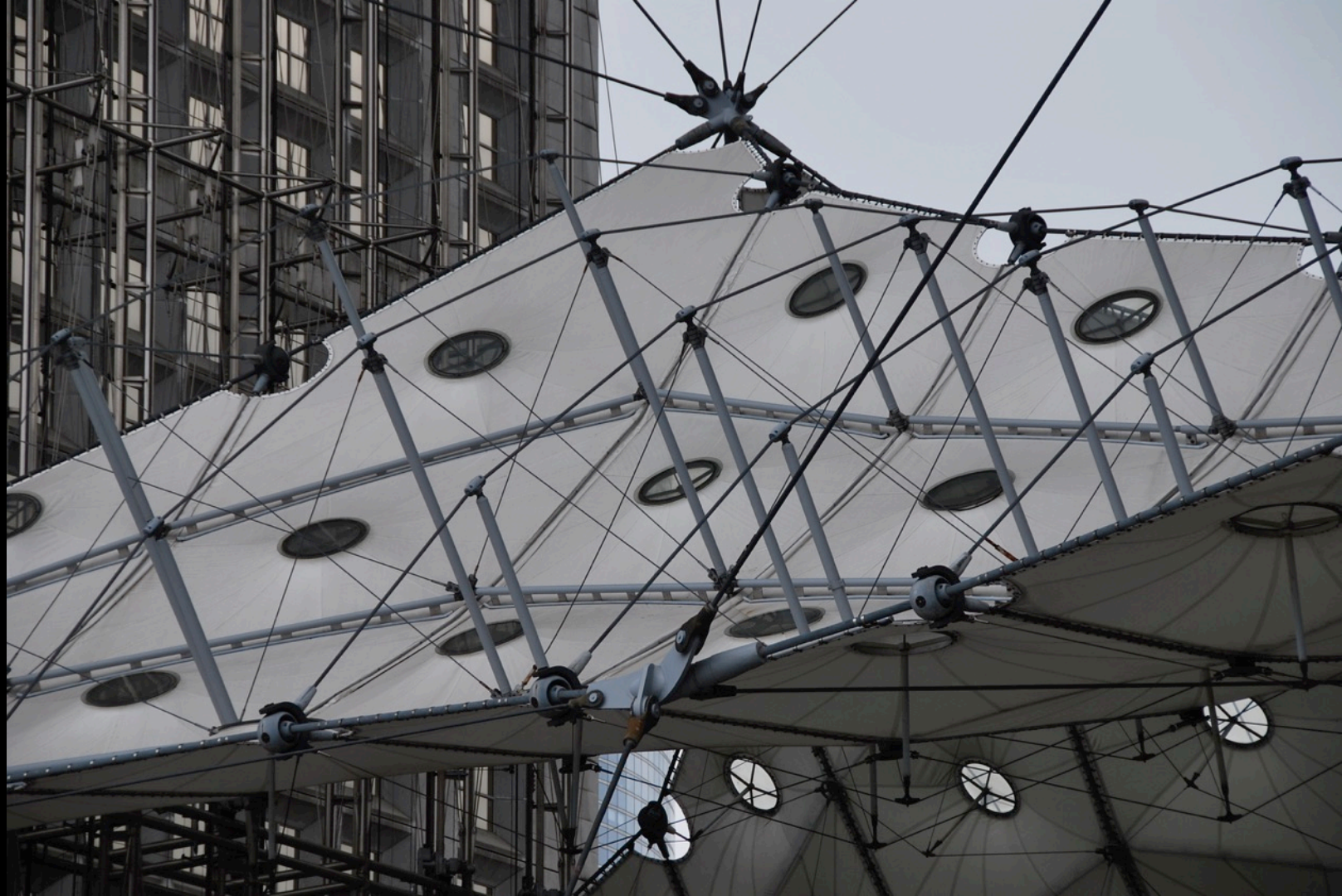































MIT Department of Brain and Cognitive  
Sciences Building  
Cambridge, Massachusetts  
Charles Correa and Associates  
2006



















Luzern Station Hall  
Luzern, Switzerland  
Santiago Calatrava  
1989





	Abfahrt	Départ	Partenza	
06:00	Düsseldorf	Amsterdam	Schiphol	0
06:05	Düsseldorf	Frankfurt	Hahn	0
06:15	Düsseldorf	Zürich	Kloten	0
06:20	Düsseldorf	Paris	CDG	0
06:25	Düsseldorf	London	Heathrow	0
06:30	Düsseldorf	Brussels	National	0
06:35	Düsseldorf	Amsterdam	Schiphol	0
06:40	Düsseldorf	Frankfurt	Hahn	0
06:45	Düsseldorf	Zürich	Kloten	0
06:50	Düsseldorf	Paris	CDG	0
06:55	Düsseldorf	London	Heathrow	0
07:00	Düsseldorf	Brussels	National	0
07:05	Düsseldorf	Amsterdam	Schiphol	0
07:10	Düsseldorf	Frankfurt	Hahn	0
07:15	Düsseldorf	Zürich	Kloten	0
07:20	Düsseldorf	Paris	CDG	0
07:25	Düsseldorf	London	Heathrow	0
07:30	Düsseldorf	Brussels	National	0
07:35	Düsseldorf	Amsterdam	Schiphol	0
07:40	Düsseldorf	Frankfurt	Hahn	0
07:45	Düsseldorf	Zürich	Kloten	0
07:50	Düsseldorf	Paris	CDG	0
07:55	Düsseldorf	London	Heathrow	0
08:00	Düsseldorf	Brussels	National	0
08:05	Düsseldorf	Amsterdam	Schiphol	0
08:10	Düsseldorf	Frankfurt	Hahn	0
08:15	Düsseldorf	Zürich	Kloten	0
08:20	Düsseldorf	Paris	CDG	0
08:25	Düsseldorf	London	Heathrow	0
08:30	Düsseldorf	Brussels	National	0
08:35	Düsseldorf	Amsterdam	Schiphol	0
08:40	Düsseldorf	Frankfurt	Hahn	0
08:45	Düsseldorf	Zürich	Kloten	0
08:50	Düsseldorf	Paris	CDG	0
08:55	Düsseldorf	London	Heathrow	0
09:00	Düsseldorf	Brussels	National	0
09:05	Düsseldorf	Amsterdam	Schiphol	0
09:10	Düsseldorf	Frankfurt	Hahn	0
09:15	Düsseldorf	Zürich	Kloten	0
09:20	Düsseldorf	Paris	CDG	0
09:25	Düsseldorf	London	Heathrow	0
09:30	Düsseldorf	Brussels	National	0
09:35	Düsseldorf	Amsterdam	Schiphol	0
09:40	Düsseldorf	Frankfurt	Hahn	0
09:45	Düsseldorf	Zürich	Kloten	0
09:50	Düsseldorf	Paris	CDG	0
09:55	Düsseldorf	London	Heathrow	0
10:00	Düsseldorf	Brussels	National	0
10:05	Düsseldorf	Amsterdam	Schiphol	0
10:10	Düsseldorf	Frankfurt	Hahn	0
10:15	Düsseldorf	Zürich	Kloten	0
10:20	Düsseldorf	Paris	CDG	0
10:25	Düsseldorf	London	Heathrow	0
10:30	Düsseldorf	Brussels	National	0
10:35	Düsseldorf	Amsterdam	Schiphol	0
10:40	Düsseldorf	Frankfurt	Hahn	0
10:45	Düsseldorf	Zürich	Kloten	0
10:50	Düsseldorf	Paris	CDG	0
10:55	Düsseldorf	London	Heathrow	0
11:00	Düsseldorf	Brussels	National	0
11:05	Düsseldorf	Amsterdam	Schiphol	0
11:10	Düsseldorf	Frankfurt	Hahn	0
11:15	Düsseldorf	Zürich	Kloten	0
11:20	Düsseldorf	Paris	CDG	0
11:25	Düsseldorf	London	Heathrow	0
11:30	Düsseldorf	Brussels	National	0
11:35	Düsseldorf	Amsterdam	Schiphol	0
11:40	Düsseldorf	Frankfurt	Hahn	0
11:45	Düsseldorf	Zürich	Kloten	0
11:50	Düsseldorf	Paris	CDG	0
11:55	Düsseldorf	London	Heathrow	0
12:00	Düsseldorf	Brussels	National	0
12:05	Düsseldorf	Amsterdam	Schiphol	0
12:10	Düsseldorf	Frankfurt	Hahn	0
12:15	Düsseldorf	Zürich	Kloten	0
12:20	Düsseldorf	Paris	CDG	0
12:25	Düsseldorf	London	Heathrow	0
12:30	Düsseldorf	Brussels	National	0
12:35	Düsseldorf	Amsterdam	Schiphol	0
12:40	Düsseldorf	Frankfurt	Hahn	0
12:45	Düsseldorf	Zürich	Kloten	0
12:50	Düsseldorf	Paris	CDG	0
12:55	Düsseldorf	London	Heathrow	0
13:00	Düsseldorf	Brussels	National	0
13:05	Düsseldorf	Amsterdam	Schiphol	0
13:10	Düsseldorf	Frankfurt	Hahn	0
13:15	Düsseldorf	Zürich	Kloten	0
13:20	Düsseldorf	Paris	CDG	0
13:25	Düsseldorf	London	Heathrow	0
13:30	Düsseldorf	Brussels	National	0
13:35	Düsseldorf	Amsterdam	Schiphol	0
13:40	Düsseldorf	Frankfurt	Hahn	0
13:45	Düsseldorf	Zürich	Kloten	0
13:50	Düsseldorf	Paris	CDG	0
13:55	Düsseldorf	London	Heathrow	0
14:00	Düsseldorf	Brussels	National	0
14:05	Düsseldorf	Amsterdam	Schiphol	0
14:10	Düsseldorf	Frankfurt	Hahn	0
14:15	Düsseldorf	Zürich	Kloten	0
14:20	Düsseldorf	Paris	CDG	0
14:25	Düsseldorf	London	Heathrow	0
14:30	Düsseldorf	Brussels	National	0
14:35	Düsseldorf	Amsterdam	Schiphol	0
14:40	Düsseldorf	Frankfurt	Hahn	0
14:45	Düsseldorf	Zürich	Kloten	0
14:50	Düsseldorf	Paris	CDG	0
14:55	Düsseldorf	London	Heathrow	0
15:00	Düsseldorf	Brussels	National	0
15:05	Düsseldorf	Amsterdam	Schiphol	0
15:10	Düsseldorf	Frankfurt	Hahn	0
15:15	Düsseldorf	Zürich	Kloten	0
15:20	Düsseldorf	Paris	CDG	0
15:25	Düsseldorf	London	Heathrow	0
15:30	Düsseldorf	Brussels	National	0
15:35	Düsseldorf	Amsterdam	Schiphol	0
15:40	Düsseldorf	Frankfurt	Hahn	0
15:45	Düsseldorf	Zürich	Kloten	0
15:50	Düsseldorf	Paris	CDG	0
15:55	Düsseldorf	London	Heathrow	0
16:00	Düsseldorf	Brussels	National	0
16:05	Düsseldorf	Amsterdam	Schiphol	0
16:10	Düsseldorf	Frankfurt	Hahn	0
16:15	Düsseldorf	Zürich	Kloten	0
16:20	Düsseldorf	Paris	CDG	0
16:25	Düsseldorf	London	Heathrow	0
16:30	Düsseldorf	Brussels	National	0
16:35	Düsseldorf	Amsterdam	Schiphol	0
16:40	Düsseldorf	Frankfurt	Hahn	0
16:45	Düsseldorf	Zürich	Kloten	0
16:50	Düsseldorf	Paris	CDG	0
16:55	Düsseldorf	London	Heathrow	0
17:00	Düsseldorf	Brussels	National	0
17:05	Düsseldorf	Amsterdam	Schiphol	0
17:10	Düsseldorf	Frankfurt	Hahn	0
17:15	Düsseldorf	Zürich	Kloten	0
17:20	Düsseldorf	Paris	CDG	0
17:25	Düsseldorf	London	Heathrow	0
17:30	Düsseldorf	Brussels	National	0
17:35	Düsseldorf	Amsterdam	Schiphol	0
17:40	Düsseldorf	Frankfurt	Hahn	0
17:45	Düsseldorf	Zürich	Kloten	0
17:50	Düsseldorf	Paris	CDG	0
17:55	Düsseldorf	London	Heathrow	0
18:00	Düsseldorf	Brussels	National	0
18:05	Düsseldorf	Amsterdam	Schiphol	0
18:10	Düsseldorf	Frankfurt	Hahn	0
18:15	Düsseldorf	Zürich	Kloten	0
18:20	Düsseldorf	Paris	CDG	0
18:25	Düsseldorf	London	Heathrow	0
18:30	Düsseldorf	Brussels	National	0
18:35	Düsseldorf	Amsterdam	Schiphol	0
18:40	Düsseldorf	Frankfurt	Hahn	0
18:45	Düsseldorf	Zürich	Kloten	0
18:50	Düsseldorf	Paris	CDG	0
18:55	Düsseldorf	London	Heathrow	0
19:00	Düsseldorf	Brussels	National	0
19:05	Düsseldorf	Amsterdam	Schiphol	0
19:10	Düsseldorf	Frankfurt	Hahn	0
19:15	Düsseldorf	Zürich	Kloten	0
19:20	Düsseldorf	Paris	CDG	0
19:25	Düsseldorf	London	Heathrow	0
19:30	Düsseldorf	Brussels	National	0
19:35	Düsseldorf	Amsterdam	Schiphol	0
19:40	Düsseldorf	Frankfurt	Hahn	0
19:45	Düsseldorf	Zürich	Kloten	0
19:50	Düsseldorf	Paris	CDG	0
19:55	Düsseldorf	London	Heathrow	0
20:00	Düsseldorf	Brussels	National	0
20:05	Düsseldorf	Amsterdam	Schiphol	0
20:10	Düsseldorf	Frankfurt	Hahn	0
20:15	Düsseldorf	Zürich	Kloten	0
20:20	Düsseldorf	Paris	CDG	0
20:25	Düsseldorf	London	Heathrow	0
20:30	Düsseldorf	Brussels	National	0
20:35	Düsseldorf	Amsterdam	Schiphol	0
20:40	Düsseldorf	Frankfurt	Hahn	0
20:45	Düsseldorf	Zürich	Kloten	0
20:50	Düsseldorf	Paris	CDG	0
20:55	Düsseldorf	London	Heathrow	0
21:00	Düsseldorf	Brussels	National	0
21:05	Düsseldorf	Amsterdam	Schiphol	0
21:10	Düsseldorf	Frankfurt	Hahn	0
21:15	Düsseldorf	Zürich	Kloten	0
21:20	Düsseldorf	Paris	CDG	0
21:25	Düsseldorf	London	Heathrow	0
21:30	Düsseldorf	Brussels	National	0
21:35	Düsseldorf	Amsterdam	Schiphol	0
21:40	Düsseldorf	Frankfurt	Hahn	0
21:45	Düsseldorf	Zürich	Kloten	0
21:50	Düsseldorf	Paris	CDG	0
21:55	Düsseldorf	London	Heathrow	0
22:00	Düsseldorf	Brussels	National	0
22:05	Düsseldorf	Amsterdam	Schiphol	0
22:10	Düsseldorf	Frankfurt	Hahn	0
22:15	Düsseldorf	Zürich	Kloten	0
22:20	Düsseldorf	Paris	CDG	0
22:25	Düsseldorf	London	Heathrow	0
22:30	Düsseldorf	Brussels	National	0
22:35	Düsseldorf	Amsterdam	Schiphol	0
22:40	Düsseldorf	Frankfurt	Hahn	0
22:45	Düsseldorf	Zürich	Kloten	0
22:50	Düsseldorf	Paris	CDG	0
22:55	Düsseldorf	London	Heathrow	0
23:00	Düsseldorf	Brussels	National	0
23:05	Düsseldorf	Amsterdam	Schiphol	0
23:10	Düsseldorf	Frankfurt	Hahn	0
23:15	Düsseldorf	Zürich	Kloten	0
23:20	Düsseldorf	Paris	CDG	0
23:25	Düsseldorf	London	Heathrow	0
23:30	Düsseldorf	Brussels	National	0
23:35	Düsseldorf	Amsterdam	Schiphol	0
23:40	Düsseldorf	Frankfurt	Hahn	0
23:45	Düsseldorf	Zürich	Kloten	0
23:50	Düsseldorf	Paris	CDG	0
23:55	Düsseldorf	London	Heathrow	0

Gardina  
+49 563 26 1000 2011, Münster, Germany

kiosk

BEZELKÖNIG

























Dulles Airport Renovation  
Washington, D.C.





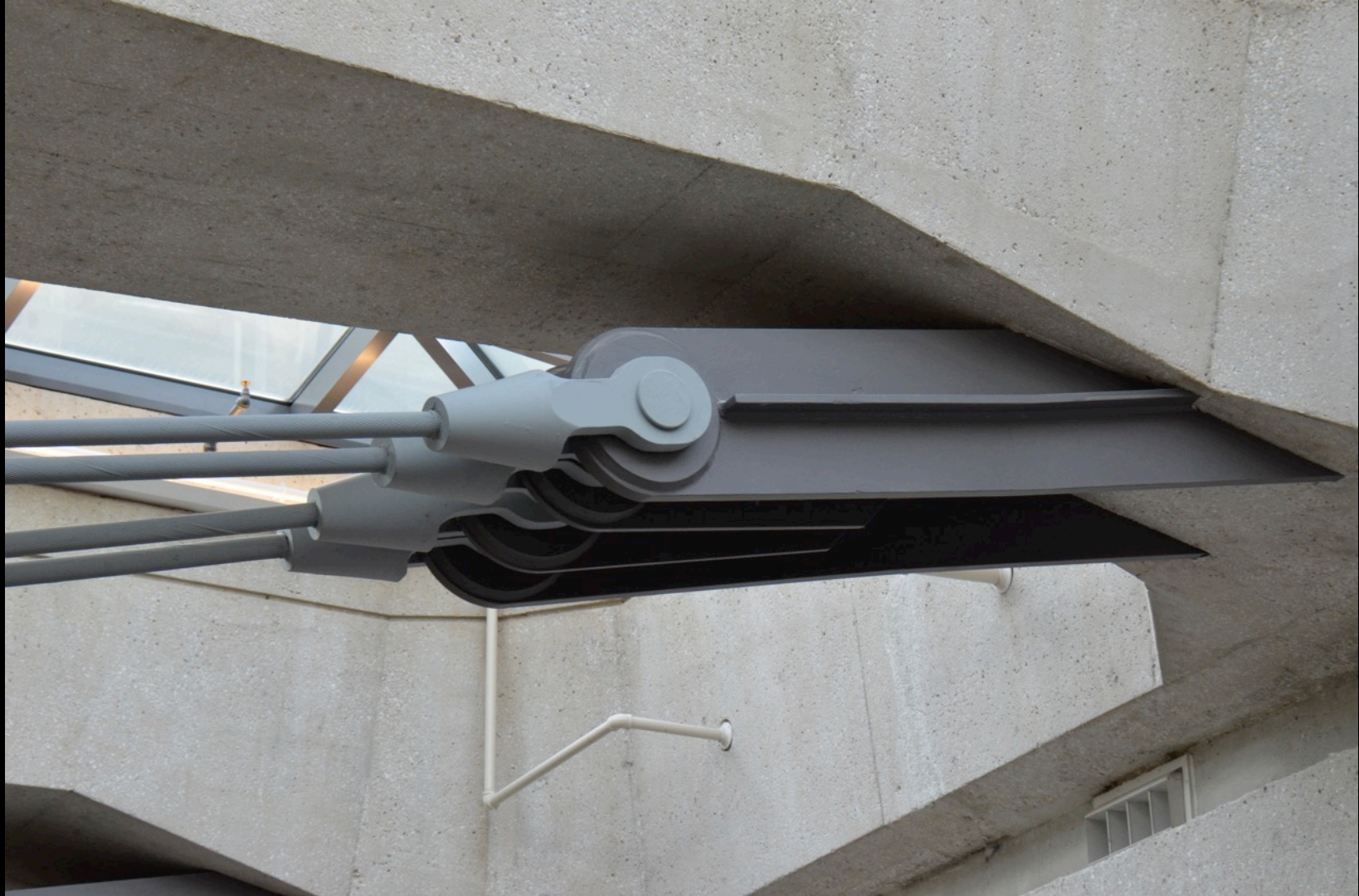



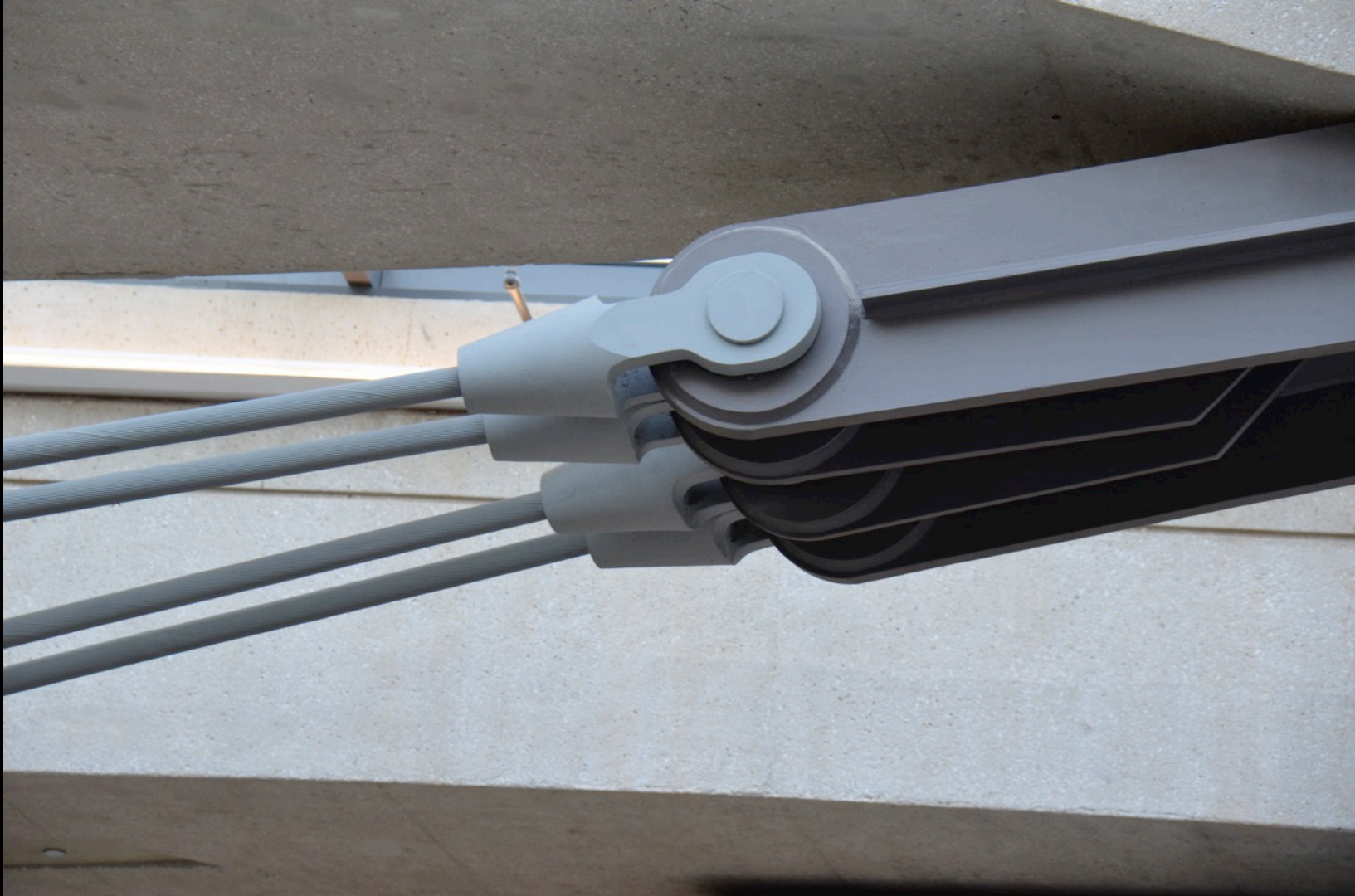





Pavilion at Canary Wharf  
London, U.K.





A photograph of the Shanghai Pudong International Airport Terminal 1, showcasing its iconic white, ribbed, cantilevered roof structure supported by a series of white, angled columns. The terminal's facade is a long, continuous glass wall. In the foreground, a white, ribbed roof structure is visible, likely part of an adjacent building or a lower level of the terminal. The sky is overcast and grey.

Shanghai Pudong International Airport  
Terminal 1  
Shanghai, China  
Paul Andreu  
1999











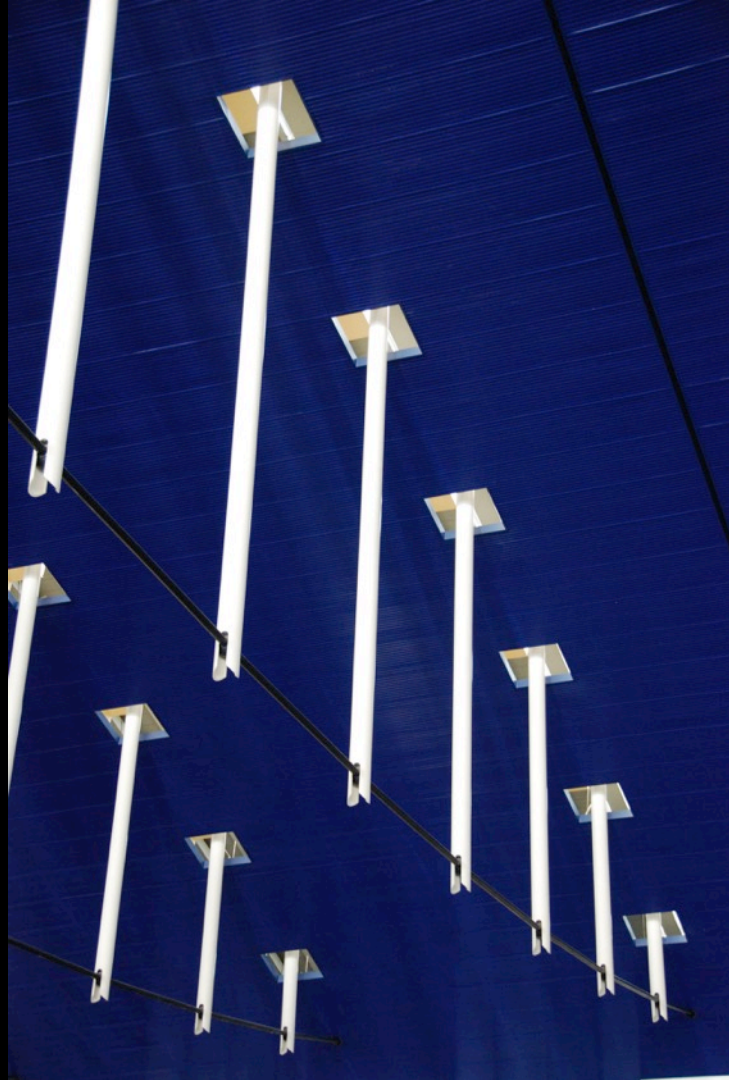

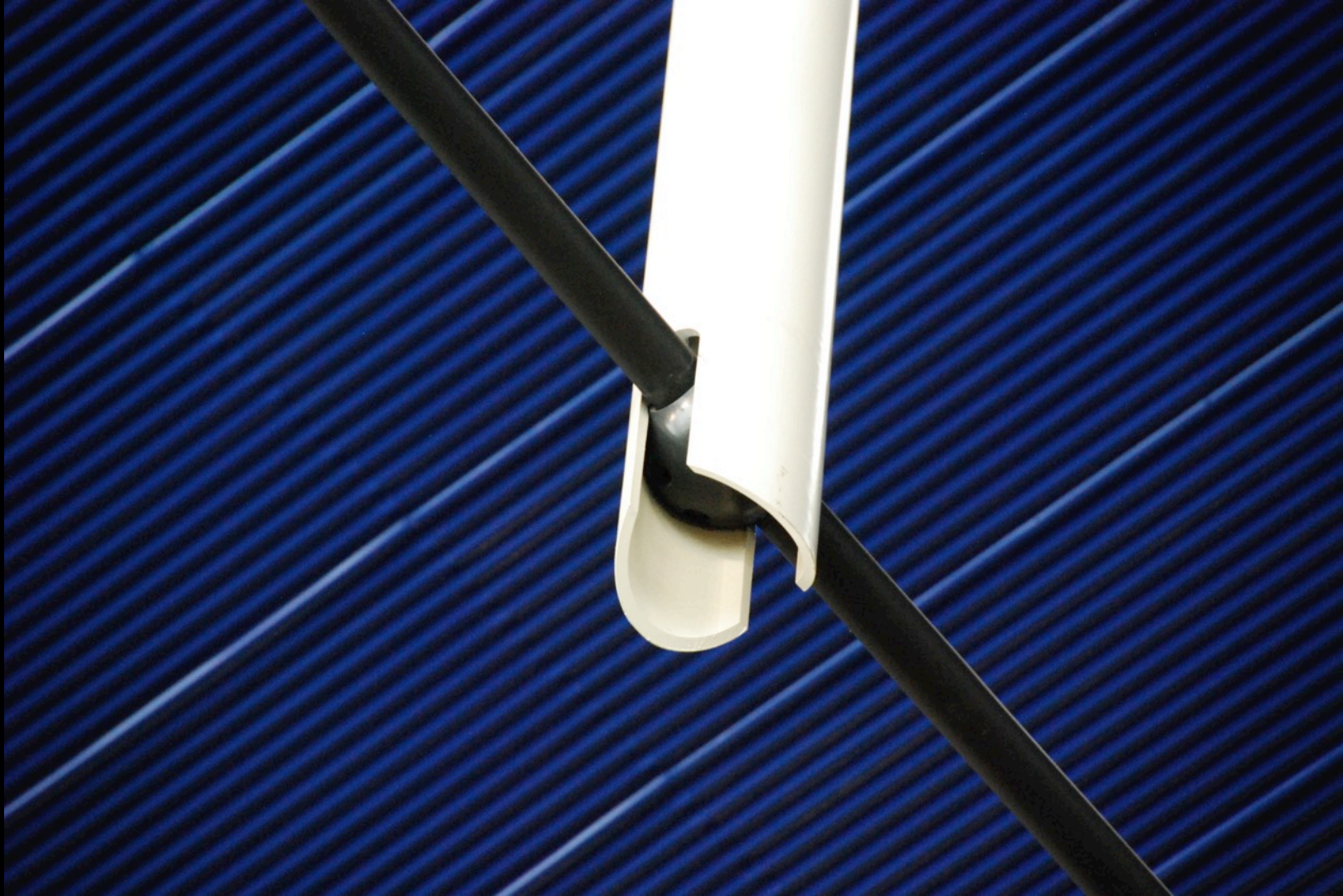





















Porto International Airport  
Porto, Portugal











Salidas 01:15  
↑ Salidas  
↑ Información  
↑ Servicios  
↑ Dirección de Bagajes  
↑ Ventas de Billetes  
↑ Ticket Post-Flight

Salidas 16:60  
↑ Salidas  
↑ Información  
↑ Servicios  
↑ Dirección de Bagajes  
↑ Ventas de Billetes  
↑ Ticket Post-Flight

























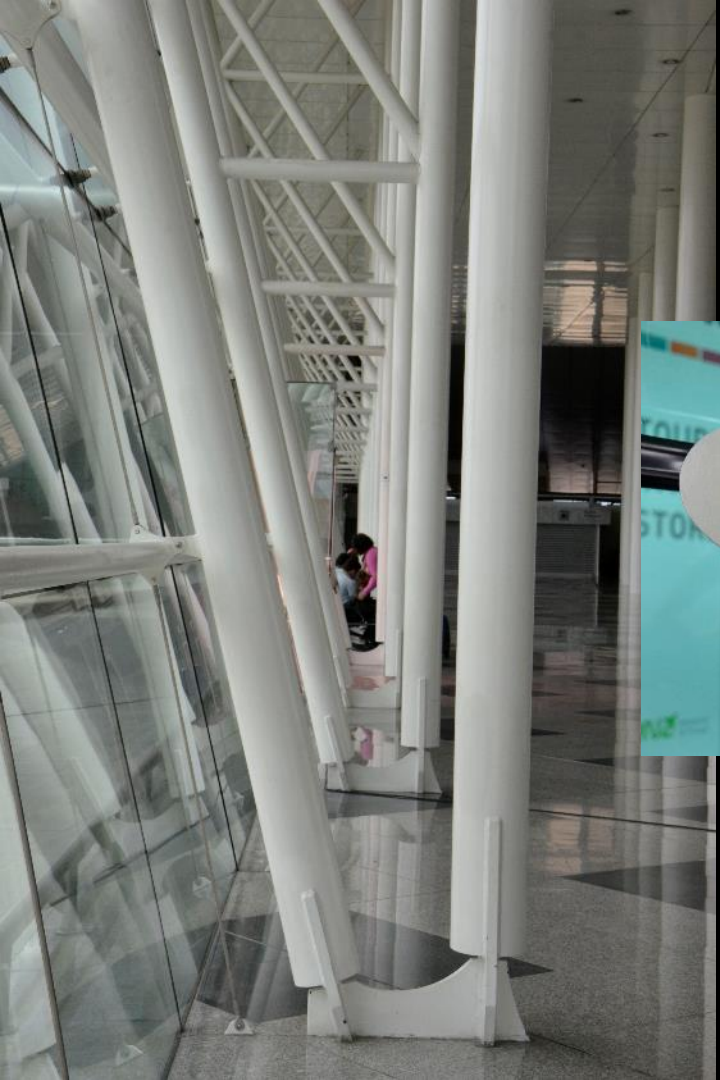



Sydney Olympic Park Aquatic  
Centre  
Sydney, Australia  
Cox Architecture  
1994



















Humberto Delgado Airport  
Lisbon, Portugal















Taikou Place Bridge  
Hong Kong

















Shanghai Oriental Sports Complex  
Shanghai, China  
Gerkan, Marg and Partners (GMP)  
2011



















儿童池  
Children's Pool  
水深 0.4米  
Water Depth 0.4m

禁止奔跑  
No Running

小心台阶  
Caution Steps

小心地滑  
Caution Slip













